

# CARMEN MINI/ MINI 1/MINI 2/MINI 3

**PL** INSTRUKCJA MONTAŻU

**GB** ASSEMBLY INSTRUCTIONS

**CZ** NÁVOD K MONTÁŽI

**SK** NÁVOD K MONTÁŽI

**HU** SZERELÉSI ÚTMUTATÓ

**F** MODEL D'EMPLOI

**D** MONTAGEANLEITUNG

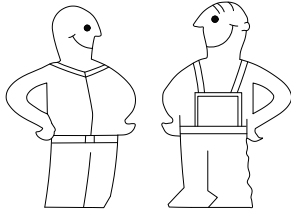

2 osoby  
2 persons  
2 osob  
2 osôb  
2 személyek  
2 personnes  
2 personen

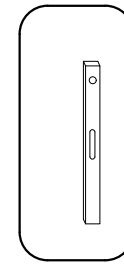
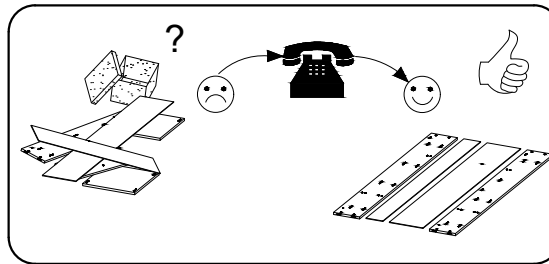
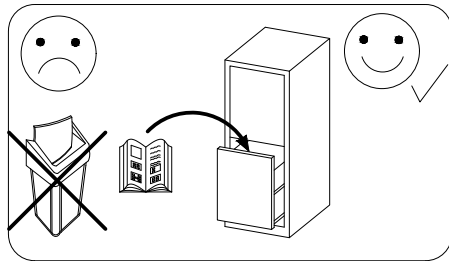
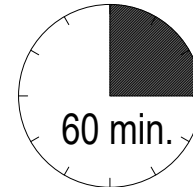

zalecane narzędzia  
recommended tools  
doporučené nástroje  
ajánlott eszközöket  
outils recommandés  
empfohlene werkzeuge

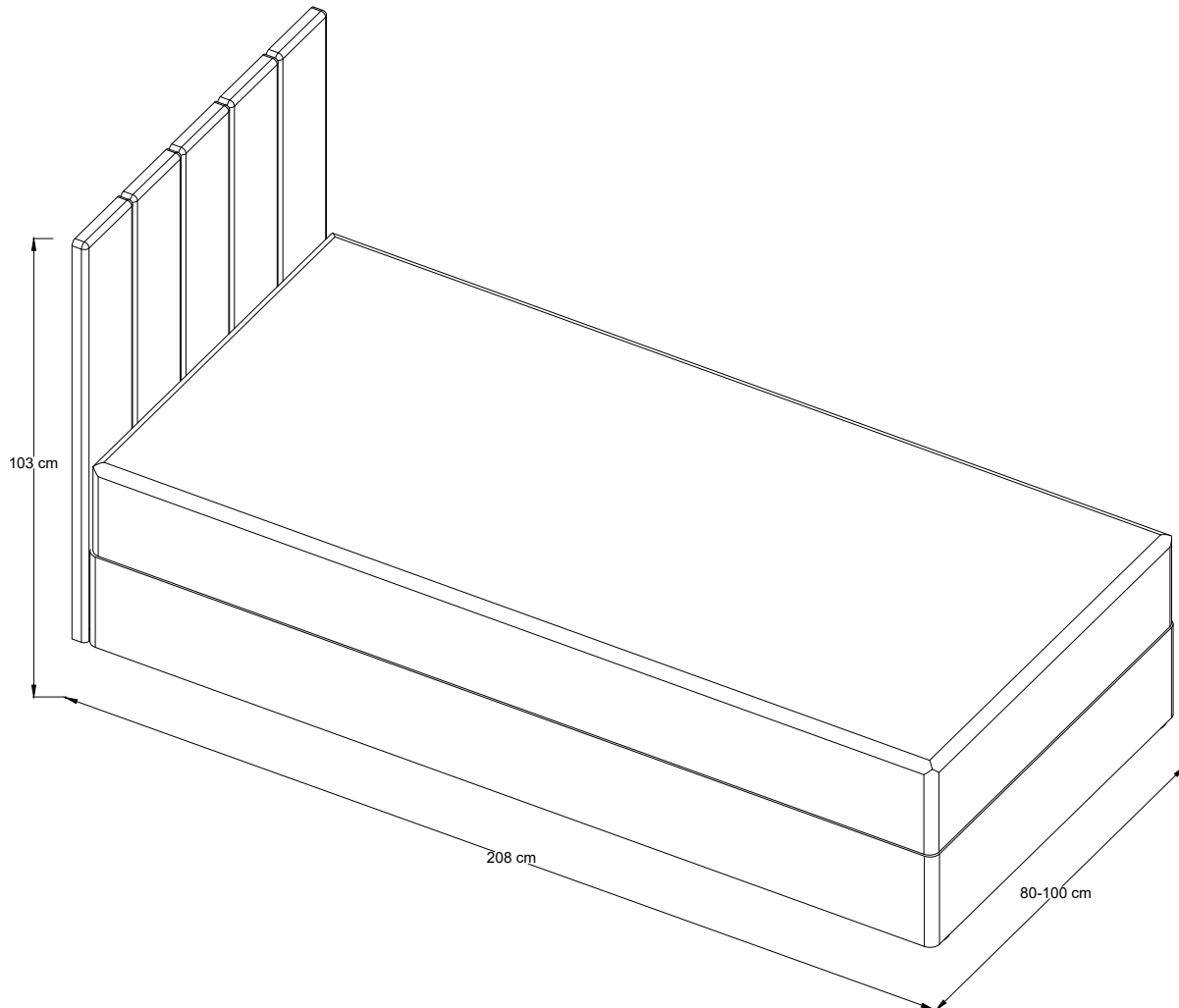

**1**

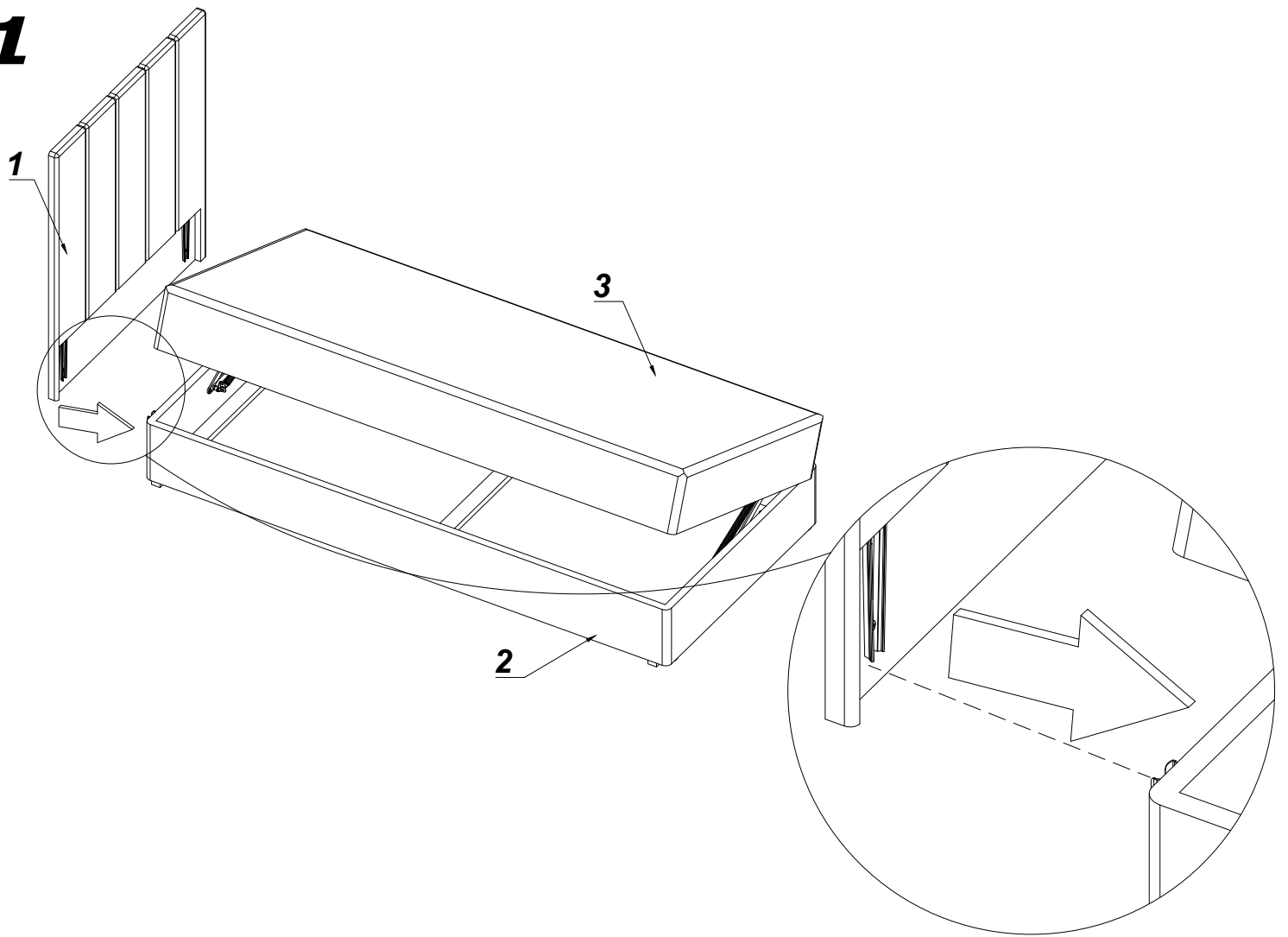

**2**

