

# JUNIOR GOLD 1

**PL** INSTRUKCJA MONTAŻU

**GB** ASSEMBLY INSTRUCTIONS

**CZ** NÁVOD K MONTÁŽI

**SK** NÁVOD K MONTÁŽI

**HU** SZERELÉSI ÚTMUTATÓ

**F** MODEL D'EMPLOI

**D** MONTAGEANLEITUNG

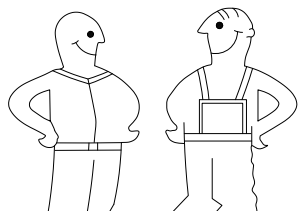

2 osoby  
2 persons  
2 osob  
2 osôb  
2 zeměkyk  
2 personnes  
2 personen

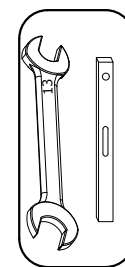
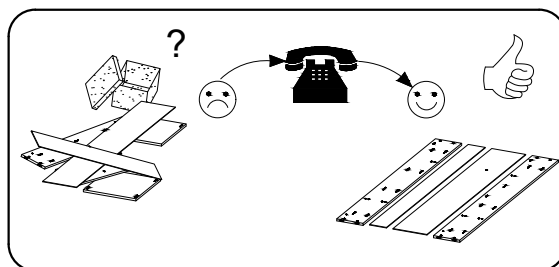
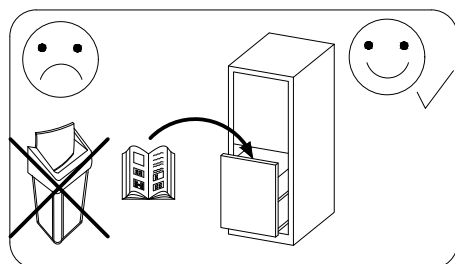
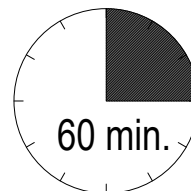

zalecane narzędzia  
recommended tools  
doporučené nástroje  
odporúčané nástroje  
ajánlott eszközöket  
outils recommandés  
empfohlene werkzeuge

## AKCESORIA / ACCESSORIES / PŘÍSLUŠENSTVÍ / KIEGÉSZÍTŐK / ACCESSOIRES / ZUBEHÖR

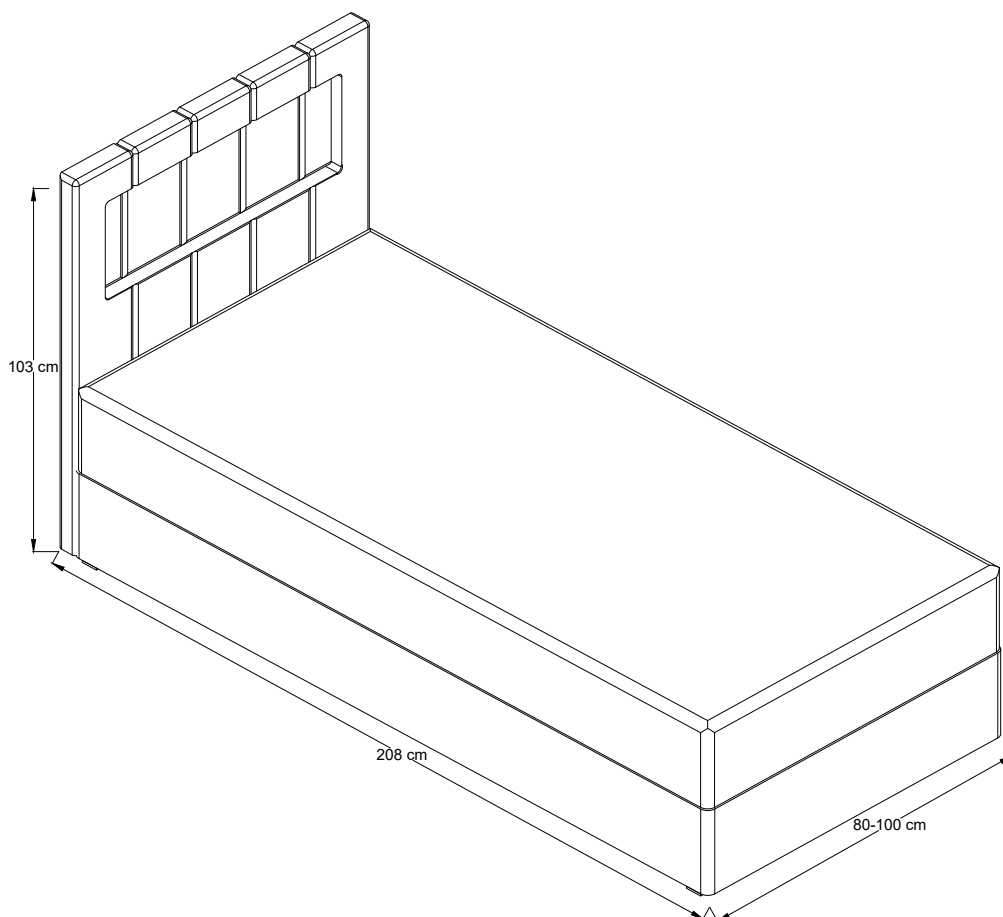
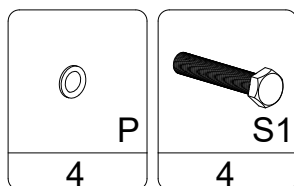

**1**

