

JUNIOR GOLD 2

(PL) INSTRUKCJA MONTAŻU

(GB) ASSEMBLY INSTRUCTIONS

(CZ) NÁVOD K MONTÁŽI

(SK) NÁVOD K MONTÁŽI

(HU) SZERELÉSI ÚTMUTATÓ

(F) MODEL D'EMPLOI

(D) MONTAGEANLEITUNG

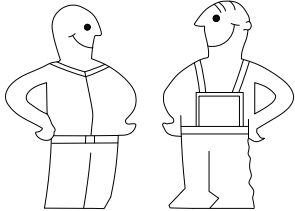

2 osoby
2 persons
2 osob
2 osôb
2 zeměkyk
2 personnes
2 personen

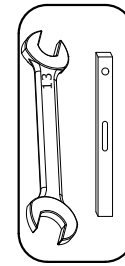
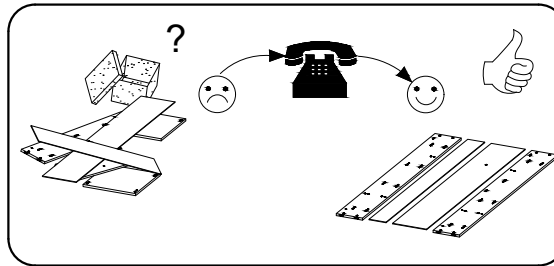
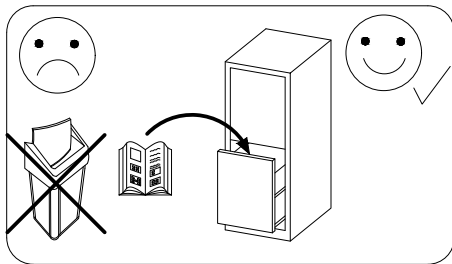
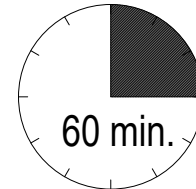

zalecane narzędzia
recommended tools
doporučené nástroje
odporučané nástroje
ajánlott eszközöket
outils recommandés
empfohlene werkzeuge

AKCESORIA / ACCESSORIES / PŘÍSLUŠENSTVÍ / KIEGÉSZÍTŐK / ACCESSOIRES / ZUBEHÖR

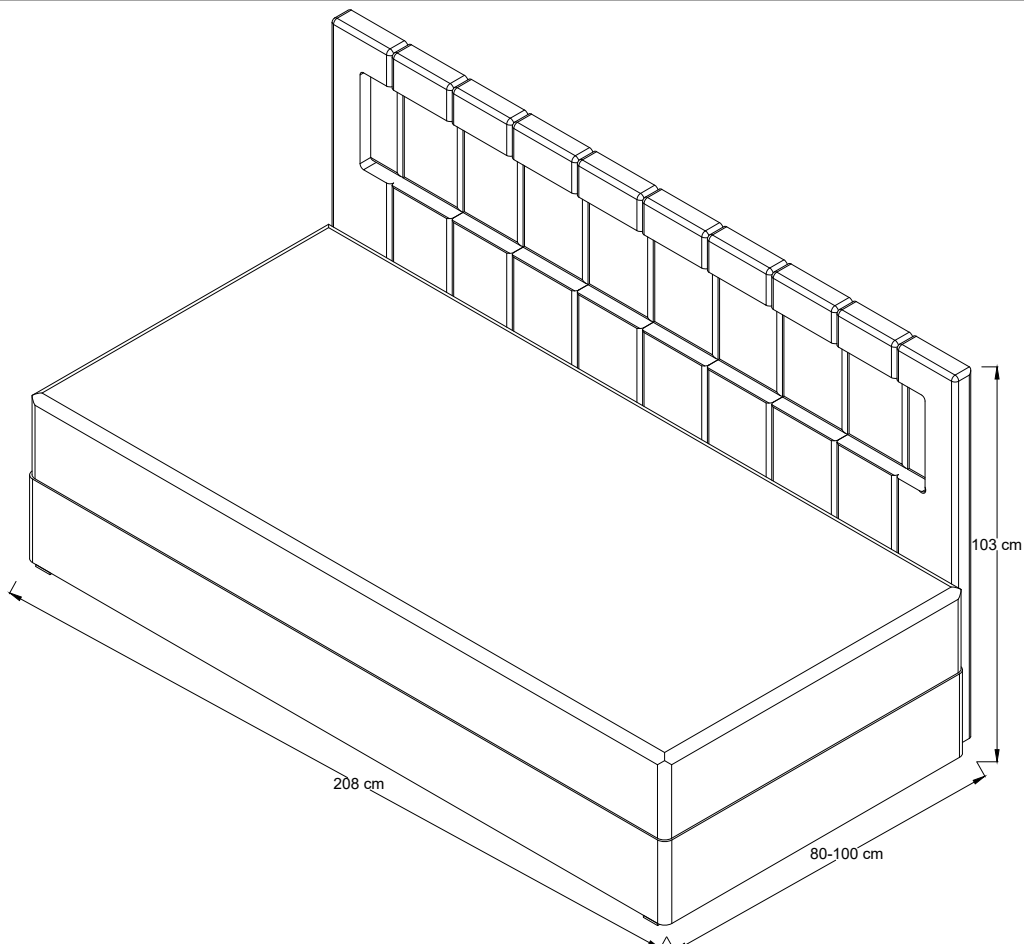
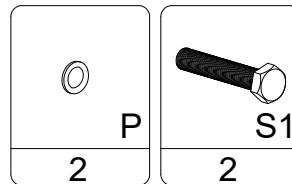

1

